

Catalogue 2025

FAST

FAST

RIA & MOSAIKO

Design Alberto Lievore

112

RIA & MOSAIKO



7613 RIA 3-SEATER SOFA
636 RIA BACKREST CUSHION 50 x 50 CM
637 RIA ARMREST CUSHION 45 x 45 CM

113

FAST



7603 RIA DINING ARMCHAIR WITH QUILTED BACKREST
634 SEAT CUSHION

118

RIA & MOSAIKO



7603 RIA DINING ARMCHAIR WITH QUILTED BACKREST
634 SEAT CUSHION

119

FAST



7611 RIA ARMCHAIR
636 RIA BACKREST CUSHION 50 x 50 CM
637 RIA ARMREST CUSHION 45 x 45 CM
3213A MOSAIKO SMALL TABLE
TA03 ONDA RUG

122

RIA & MOSAIKO



7611 RIA ARMCHAIR
636 RIA BACKREST CUSHION 50 x 50 CM
637 RIA ARMREST CUSHION 45 x 45 CM
3213A MOSAIKO SMALL TABLE
TA03 ONDA RUG

123

FAST

RIA & MOSAIKO



FAST

RIA & MOSAIKO



7603 RIA DINING ARMCHAIR WITH QUILTED BACKREST DETAIL

128



7600 RIA DINING ARMCHAIR DETAIL

129

Price List

01/10/2024 – 30/09/2025

IVA ESCLUSA / VAT FREE / OHNE MWST / HORS TVA / SIN IVA

FAST

Alluminio verniciato • Painted aluminium (Lackiertes Aluminium • Aluminium verni • Aluminio lacado)

1	Bianco • White (<i>Weiß • Blanc • Blanco</i>)
2	Nero • Black (<i>Schwarz • Noir • Negro</i>)
9	Grigio Metallo • Metallic Grey (<i>Metallgrau • Gris Métal • Gris Metálico</i>)
11	Oro Perlato • Pearly Gold (<i>Perlgold • Or Perlé • Oro Perlado</i>)
13	Azzurro Pastello • Light Blue (<i>Pastell Hellblau • Bleu Pastel • Azul Pastel</i>)
14	Grigio Polvere • Powder Grey (<i>Pulvergrau • Gris Poudré • Gris Polvo</i>)
19	Tè Verde • Green Tea (<i>Grüner Tee • Thé Vert • Té Verde</i>)
26	Bianco Antico • Antique White (<i>Antikes Weiß • Blanc Antique • Blanco Antiguo</i>)
27	Bianco Burro • Butter White (<i>Butterweiß • Blanc Beurre • Blanco Mantequilla</i>)
28	Giallo Senape • Mustard Yellow (<i>Senfgeb • Jaune Moutarde • Amarillo Mostaza</i>)
29	Rosso Autunno • Autumn Red (<i>Herbstrot • Rouge Automne • Rojo Otoño</i>)
30	Marrone Castagna • Chestnut Brown (<i>Kastanienbraun • Marron Châtaigne • Marrón Castaño</i>)
31	Verde Bottiglia • Bottle Green (<i>Flaschengrün • Vert Bouteille • Verde Botella</i>)
32	Blu Grigio • Grey Blue (<i>Blau Grau • Bleu Gris • Azul Gris</i>)

Alluminio puntinato • Speckled aluminium (Gesprenkeltes Aluminium • Aluminium granité • Aluminio moteado)

1S	Antracite • Anthracite (<i>Anthrazit • Anthracite • Antracita</i>)
2S	Grigio • Grey (<i>Grau • Gris • Gris</i>)

NaturAll

W03	Naturall Chiaro • Light Naturall (<i>Helles Naturall • Naturall Clair • Naturall Claro</i>)
-----	---

Gres • Stoneware (Feinsteinzeug • Grès • Gres)**Stoneware Range 1**

GNV	Neve • Snow (<i>Schnee • Neige • Nieve</i>)
GNO	Nocciola • Hazel (<i>Haselnuss • Noisette • Avellana</i>)
GNT	Notte • Night (<i>Nacht • Nuit • Noche</i>)

Stoneware Range 2

GPL	Polare • Polar (<i>Polar • Polaire • Polar</i>)
GDO	Dove • Dove (<i>Dove • Dove • Dove</i>)
GMN	Mezzanotte • Midnight (<i>Mitternacht • Minuit • Medianoche</i>)
GCR	Corten • Corten (<i>Corten • Corten • Corten</i>)
GFU	Grigio Fumé • Smoky Grey (<i>Rauchgrau • Gris Fumé • Gris Humo</i>)
GGC	Grigio Chiaro • Light Grey (<i>Hellgrau • Gris Clair • Gris Claro</i>)
GDG	Grigio Scuro • Dark Grey (<i>Dunkelgrau • Gris Foncé • Gris Oscuro</i>)

Pietra lavica • Lava stone

PL01	Borgogna • Burgundy (<i>Burgund • Bordeaux • Borgoña</i>)
PL02	Abisso • Abyssal (<i>Abyss • Aysse • Abismo</i>)
PL03	Foresta • Forest (<i>Forst • Forêt • Selva</i>)

Legno • Wood

L01	Iroko • Iroko (<i>Iroko • Iroko • Iroko</i>)
L02	Rovere Sbiancato • Bleached Oak (<i>Gebleichter Eiche • Chêne Blanci • Roble Blanqueado</i>)
L03	Teak • Teak (<i>Teak • Teck • Teca</i>)

Malta • Mortar

M01	Bianco Burro • Butter White (<i>Butterweiß • Blanc Beurre • Blanco Mantequilla</i>)
M02	Oro Perlato • Pearly Gold (<i>Perlgold • Or Perlé • Oro Perlado</i>)
M03	Giallo Senape • Mustard Yellow (<i>Senfgeb • Jaune Moutarde • Amarillo Mostaza</i>)
M04	Grigio Metallo • Metallic Grey (<i>Metallgrau • Gris Métal • Gris Metálico</i>)

HPL

AN	Antracite • Anthracite (<i>Anthrazit • Anthracite • Antracita</i>)
BI	Bianco • White (<i>Weiß • Blanc • Blanco</i>)
NE	Nero • Black (<i>Schwarz • Noir • Negro</i>)
TA	Tortora • Taupe (<i>Taupe • Gris Tourterelle • Gris Paloma</i>)

Tessuti • Fabrics (Stoffe • Tissus • Tejidos)**Fabrics Range 1****Solids**

STA	Tortora • Taupe (<i>Taupe • Gris Tourterelle • Gris Paloma</i>)
SLN	Lino • Linen (<i>Leinen • Lin • Lino</i>)
SCH	Champagne • Champagne (<i>Champagne • Champagne • Champán</i>)
SPE	Perla • Pearl (<i>Perle • Perle • Perla</i>)
SMG	Grigio Minerale • Mineral Grey (<i>Mineral Grau • Gris minéral • Gris Mineral</i>)
SGR	Grigio • Grey (<i>Grau • Gris • Gris</i>)
SCI	Cannella • Cinnamon (<i>Kannamon • Cannelle • Canela</i>)
SCC	Cioccolato • Choco (<i>Schokolade • Chocolat • Chocolate</i>)
SNÄ	Navy • Navy (<i>Navy • Navy • Navy</i>)

Liso

LCE	Cenere • Ash (<i>Asche • Cendre • Ceniza</i>)
LGF	Grafite • Graphite (<i>Graphit • Graphite • Grafito</i>)
LSA	Salvia • Sage (<i>Salbei • Saugé • Sage</i>)

Fabrics Range 2**Heritage recycle**

HDS	Deserto • Desert (<i>Wüste • Désert • Desierto</i>)
HCE	Cereale • Cereal (<i>Müsli • Céréales • Cereales</i>)
HRO	Strada • Road (<i>Straße • Route • Calle</i>)
HCO	Rame • Coppery (<i>Kupfer • Cuivre • Cobre</i>)
HPI	Pistacchio • Pistachio (<i>Pistazie • Pistache • Pistacho</i>)
HOL	Oliva • Olive (<i>Olive • Olive • Oliva</i>)
HAL	Pino • Alpine (<i>Kiefer • Pin • Pino</i>)
HGR	Grano • Grain (<i>Weizen • Grain • Trigo</i>)
HJE	Jeans • Jeans (<i>Jeans • Jeans • Jeans</i>)
HCF	Caffè • Coffee (<i>Kaffee • Café • Café</i>)

Positano

POME	Meringa • Meringue (<i>Meringue • Meringue • Merengue</i>)
POQU	Quinoa • Quinoa (<i>Quinoa • Quinoa • Quinoa</i>)
POTB	Tobacco • Tobacco (<i>Tabak • Tabac • Tabaco</i>)
POAL	Aloe • Aloe (<i>Aloe Aloe Aloe</i>)
POCL	Nuvola • Cloud (<i>Wolke • Nuage • Nube</i>)
POSL	Ardesia • Slate (<i>Schiefer • Ardoise • Pizarra</i>)
POOC	Ottanio • Octanio (<i>Oktan-Grün • Octane • Verde Azulado</i>)
POBB	Mirtillo • Blueberry (<i>Heidelbeere • Myrtle • Arándano</i>)

Fabrics Range Laminated**Liso Laminated**

LCEL	Cenere • Ash (<i>Asche • Cendre • Ceniza</i>)
LGFL	Grafite • Graphite (<i>Graphit • Graphite • Grafito</i>)
LSAL	Salvia • Sage (<i>Salbei • Saugé • Sage</i>)

Solids Laminated

SMIL	Minerale • Mineral (<i>Mineral • Minéraux • Mineral</i>)
STAL	Tortora • Taupe (<i>Taupe • Gris Tourterelle • Gris Paloma</i>)

Fabrics Range Fireproof**Atrium**

ATAM	Amazzonia • Amazonia (<i>Amazonas • Amazonie • Amazonia</i>)
ATAP	Albicocca • Apricot (<i>Aprikose • Abricot • Albaricoque</i>)
ATCY	Canyon • Canyon (<i>Canyon • Canyon • Canyon</i>)
ATDS	Mare Profondo • Deep Sea (<i>Tiefsee • Mer Profonde • Mar Profundo</i>)
ATLI	Lime • Lime (<i>Lime • Lime • Lime</i>)
ATPR	Pergamena • Parchment (<i>Pergament • Parchemin • Pergamino</i>)
ATSV	Savana • Savannah (<i>Savanne • Savane • Sabana</i>)
ATST	Tempesta • Storm (<i>Sturm • Tempête • Tormenta</i>)
ATVO	Vulcano • Volcano (<i>Vulcano • Volcan • Volcán</i>)
ATWM	Muschio Bianco • White Musk (<i>Weißer Moschus • Musc Blanc • Almizcle Blanco</i>)

Fabrics Range 3**Lopi**

LOCH	Carbone • Charcoal (<i>Kohle • Charbon • Carbón</i>)
LOMR	Marmo • Marble (<i>Marmor • Marbre • Mármol</i>)
LOSB	Sabbia • Sand (<i>Sand • Sable • Arena</i>)
LOCP	Cappuccino • Cappuccino (<i>Cappuccino • Cappuccino • Cappuccino</i>)
LOGV	Ghiaia • Gravel (<i>Kies • Gravier • Grava</i>)
LOSU	Alba • Sunrise (<i>Sonnenaufgang • Soleil Levant • Amanecer</i>)

Slow

SLCN	Cotone • Cotton (<i>Baumwolle • Coton • Algodón</i>)
SLPA	Paprika • Paprika (<i>Paprika • Paprika • Páprika</i>)
SLMF	Latte-menta • Mint Frost (<i>Milch-Minze • Menthe-lait • Leche-menta</i>)
SLSW	Alghe • Seaweed (<i>Algen • Algue • Algas</i>)

Gaià

GASF	Fiocco Di Neve • Snowflake (<i>Schneeflocke • Floccon De Neige • Copo De Neve</i>)
GAVA	Vaniglia • Vanilla (<i>Vanille • Vanille • Vainilla</i>)
GASG	Grigio Conchiglia • Seashell Grey (<i>Muschel Grau • Gris Coquillage • Gris Concha</i>)
GAME	Meteorite • Meteorite (<i>Meteorit • Météorite • Meteorito</i>)

Mojito

MODU	Duna • Dune (<i>Düne • Dune • Duna</i>)
MOBR	Bronzo • Bronze (<i>Bronze • Bronze • Bronce</i>)
MOIV	Avorio • Ivory (<i>Elfenbein • Ivoire • Marfil</i>)
MOCA	Caramello • Caramel (<i>Karamell • Caramel • Caramelo</i>)

Cosmopolitan

COWL	Bosco • Woodland (<i>Wald • Bois • Bosque</i>)
COWA	Onde • Waves (<i>Wellen • Vagues • Ondas</i>)
COMU	Fungo • Mushroom (<i>Pilz • Champignon • Hongo</i>)

Navarone

NVSU	Zucchero • Sugar (<i>Zucker • Sucre • Azúcar</i>)
NVSI	Seta • Silk (<i>Seide • Soie • Seda</i>)
NVFL	Fiamma • Flame (<i>Flamme • Flamme • Flame</i>)
NVTA	Grigio Tortora • Taupe Grey (<i>Taubengrau • Gris Tourterelle • Gris Paloma</i>)
NVMO	Moka • Moka (<i>Moka • Moka • Moka</i>)
NVMA	Blu Marino • Marine (<i>Meeresblau • Bleu Mer • Azul Marino</i>)
NVGL	Ghiacciaio • Glacier (<i>Gletscher • Glacier • Glaciér</i>)

Delta

DECY	Cipresso • Cypress (<i>Zypern • Chypre • Chipre</i>)
DESP	Zaffiro • Shapphire (<i>Shapphire • Shapphire • Zafiro</i>)
DEAM	Acquamarina • Acquamarine (<i>Aquamarine • Aquamarine • Aquamarina</i>)
DEDU	Polvere • Dust (<i>Pulver • Poudre • Polvo</i>)
DEWA	Wafer • Wafer (<i>Wafer • Wafer • Wafer</i>)
DEPE	Pecan • Pecan (<i>Pecan • Pécan • Pecán</i>)
DECN	Zucchero Filato • Cotton Candy (<i>Glaszucker • Barbe À Papa • Algodón De Azúcar</i>)
DESA	Salmone • Salmon (<i>Lachs • Saumon • Salmón</i>)
DEMA	Magnete • Magnet (<i>Magnet • Magnet • Magnet</i>)

Iris

IRYO	Yogurt • Yogurt (<i>Yogurt • Yogurt • Yogurt</i>)
IRCH	Ciliegia • Cherry (<i>Kirsche • Cerise • Cereza</i>)
IRST	Corda • String (<i>Seil • Corde • Cuerda</i>)
IROA	Avena • Oat (<i>Hafer • Avoine • Avena</i>)
IRNE	Nettuno • Neptune (<i>Neptun • Neptune • Neptuno</i>)

Batyline • Batyline**Batyline Range 1**

BBI	Bianco • White (<i>Weiß • Blanc • Blanco</i>)
BBR	Blu Ardesia • Slate Blue (<i>Schiefer Blau • Bleu Ardoise • Azul Pizarra</i>)
BEC	Ecru • Ecru (<i>Ecru • Ecru • Ecru</i>)
BGR	Grigio • Grey (<i>Grau • Gris • Gris</i>)
BMA	Marrone • Brown (<i>Braun • Marron • Marrón</i>)
BNE	Nero • Black (<i>Schwarz • Noir • Negro</i>)
BVE	Verde • Green (<i>Grün • Vert • Verde</i>)

Batyline Range 2

BCA	Cacao • Cacao (Kakao • Cacao • Cacao)
BBE	Beige • Beige (Beige • Beige • Beige)
BMK	Latte • Milk (Milch • Lait • Leche)

Similpelle • Leatherette

SP01	Ambra • Amber (Bernstein • Ambre • Ámbar)
SP02	Papiro • Papyrus (Papyrus • Papyrus • Papiro)
SP03	Cashmere • Cashmere (Kaschmir • Cachemire • Cachemira)
SP04	Nero Puro • Pure Black (Reines Schwarz • Noir Pur • Negro Puro)

Feltro • Felt (Filz • Feutre • Fieltro)

FCL	Colonia • Colonial Blue (Kolonial Blau • Colonial Bleu • Azul Colonial)
FDG	Grigio Scuro • Dark Grey (Dunkelgrau • Gris Foncé • Gris Oscuro)
FPN	Panna • Cream (Creme • Crème • Crema)
FRA	Rame • Copper (Kupfer • Cuivre • Cobre)
FTA	Tortora • Taupe (Taupe • Gris Tourterelle • Gris Paloma)

Corde • Ropes (Schnüre • Cordes • Cuerdas)

C01	Arizona • Arizona (Arizona • Arizona • Arizona)
C02	Sabbia Nera • Black Sand (Schwarzen Sand • Sable Noir • Arena Negra)
C03	Menta • Mint (Minze • Menthe • Menta)
C04	Luna • Moon (Mond • Lune • Luna)
C05	Roccia • Rock (Stein • Rocher • Roca)
C06	Tramonto • Sunset (Sonnenuntergang • Crépuscule • Puesta de Sol)
C07	Oceano • Ocean (Ozean • Océan • Océano)
C08	Brownie • Brownie (Brownie • Brownie • Brownie)

Corde piatte • Flat ropes (Flache Schnüre • Cordes plates • Cuerdas planas)

F01	Arizona • Arizona (Arizona • Arizona • Arizona)
F02	Sabbia Nera • Black Sand (Schwarzen Sand • Sable Noir • Arena Negra)
F03	Menta • Mint (Minze • Menthe • Menta)
F04	Luna • Moon (Mond • Lune • Luna)
F05	Roccia • Rock (Stein • Rocher • Roca)
F07	Oceano • Ocean (Ozean • Océan • Océano)
F08	Brownie • Brownie (Brownie • Brownie • Brownie)



USO ESTERNO • OUTDOOR USE

Il prodotto è utilizzabile all'esterno, senza elevata manutenzione in caso di pioggia debole o elevata (per prodotti solo alluminio, alluminio puntinato e NaturAll, alluminio con gres, alluminio con malta, alluminio con pietra lavica, alluminio con batyline, alluminio con corda/corda piatta e alluminio con HPL)
The product can be used outdoor without high maintenance in weak or heavy rain (only for products in aluminium, speckled aluminium and naturall, aluminium with stoneware, aluminium with mortar, aluminium with lava stone, aluminium with batyline, aluminium with rope/flat rope and aluminium with HPL)



USO ESTERNO CON MANUTENZIONE • OUTDOOR USE AND MAINTENANCE

Il prodotto è utilizzabile all'esterno, il tessuto è impermeabile all'acqua ma in caso di pioggia elevata si consiglia una manutenzione o l'utilizzo delle cover protettive (per prodotti in alluminio con tessuti range laminati e alluminio con similpelle)
The product can be used outdoor, and the fabric is waterproof, but in case of heavy rain, it is recommended a maintenance or the use of the protective covers (for products in aluminum with laminated range fabrics and aluminum with leatherette)



USO ESTERNO CON ATTENZIONE • OUTDOOR USE AND CAUTION

Il prodotto è utilizzabile all'esterno, il tessuto non è impermeabile all'acqua, in caso di pioggia debole o elevata si consiglia di ritirare i cuscini o utilizzare le cover protettive (per prodotti in alluminio con tessuti range 1-2-3)
The product can be used outdoor, the fabric is not waterproof. In case of weak or heavy rain it is recommended to remove the cushions or use the protective covers (for products in aluminum with fabrics range 1-2-3)



USO ESTERNO CON ATTENZIONE E TESSUTO IGNIFUGO • OUTDOOR USE AND CAUTION - FIREPROOF FABRIC

Il prodotto è utilizzabile all'esterno, è dotato di un tessuto ignifugo non impermeabile all'acqua, in caso di pioggia debole o elevata si consiglia di ritirare i cuscini o utilizzare le cover protettive (per prodotti in alluminio con tessuti range ignifughi)
The product can be used outdoor, it is equipped with a fireproof fabric that is not waterproof. In case of weak or heavy rain, it is recommended to remove the cushions or use the protective covers (for products in aluminum with fireproof range fabrics)



USO ESTERNO SOTTO COPERTURA • SHELTERED OUTDOOR USE ONLY

Il prodotto è utilizzabile all'esterno, si consiglia di utilizzarlo sotto una copertura o sotto un portico (per prodotti in alluminio con iroko, alluminio con rovere sbiancato, alluminio con teak e i feltri)
The product can be used outdoor, it is recommended to use it sheltered or under a porch (for products in aluminum with iroko, aluminum with bleached oak, aluminum with teak, and felts)



Impilabile • Stackable (Stapelbar • Empilable • Apilable)



Peso lordo • Gross weight (Bruttogewicht • Poids brut • Peso bruto)



Imballo • Packaging (Verpackung • Embalage • Embalaje)



Assemblato • Assembled (Montiert • Monté • Montado)



Disassemblato • Disassembled (Demontiert • Demonté • Desmontado)



Dimensione e volume • Dimension and volume (Maße und Volumen • Dimension et volume • Medida y volumen)



Personalizzabile previa valutazione • Custom on evaluation (Custom zur Bewertung • Custom sur l'évaluation • Custom en evaluación)



Personalizzabile in altezza • Custom in height (Custom in der Höhe • Custom en hauteur • Custom en altura)



Personalizzabile in lunghezza • Custom in length (Custom in der Länge • Custom en longueur • Custom en longitud)



Personalizzabile in larghezza • Custom in width (Custom in die breite • Custom en largeur • Custom en anchura)



Certificazione ambientale • Environmental product declaration (Umweltzertifizierung • Déclaration environnementale • Declaración ambiental)

RIA

Design Alberto Lievore

^{IT} Ria è una linea di sedute dal design particolarmente confortevole e orientato al benessere. Disponibile in un'ampia varietà di finiture e dimensioni, Ria consente la massima personalizzazione nel comporre il proprio ambiente outdoor in situazioni e stagioni diverse, sempre all'insegna della praticità e della comodità.

^{EN} Ria is a collection of seats that accommodate the comfort and well-being of the body. Available in a broad variety of finishes and sizes, Ria allows maximum freedom in composing your outdoor environment in different situations and seasons, with a constant focus on practicality and comfort.



Impilabilità • Stackability



Scalabilità del prodotto • Product scalability

7600



30 kg 4 ASS. cm 73 x 69 x 96 m³ 0,483



IT Poltroncina in alluminio verniciato
 EN Dining armchair in painted aluminium
 DE Armlehnstuhl aus lackiertem Aluminium
 FR Petit fauteuil en aluminium verni
 ES Butaca en aluminio lacado



Painted alu

Price

ALL COLOURS

€ 340

7602



34 kg 4 ASS. cm 73 x 69 x 96 m³ 0,483



IT Poltroncina in alluminio verniciato con intreccio parziale
 EN Dining armchair in painted aluminium with partially woven rope
 DE Armlehnstuhl aus lackiertem Aluminium mit teilweise Geflecht
 FR Petit fauteuil en aluminium verni avec tressage partiel
 ES Butaca en aluminio lacado con entrelazado parcial



Painted alu

Rope

Price

ALL COLOURS

ALL ROPES

€ 565

7601

15 kg 1 ASS. cm 73 x 57 x 96 m³ 0,399



IT Poltroncina in alluminio verniciato con intreccio completo
 EN Dining armchair in painted aluminium with fully woven rope
 DE Armlehnstuhl aus lackiertem Aluminium mit komplettem Geflecht
 FR Petit fauteuil en aluminium verni avec tressage complet
 ES Butaca en aluminio lacado con entrelazado completo



Painted alu

Rope

Price

ALL COLOURS

ALL ROPES

€ 820

7603

16 kg 1 ASS. cm 73 x 57 x 96 m³ 0,399



IT Poltroncina in alluminio verniciato con schienale trapuntato
 EN Dining armchair in painted aluminium with quilted backrest
 DE Armlehnstuhl aus lackiertem Aluminium mit gesteppter Rückenlehne
 FR Petit fauteuil en aluminium verni avec dossier matelassé
 ES Butaca en aluminio lacado con respaldo acolchado

Painted alu

ALL COLOURS

Fabric

• RANGE 1	€ 985
• RANGE 2	€ 1.065
• RANGE 3	€ 1.135
• RANGE LAMINATED	€ 1.065
• RANGE FIREPROOF	€ 1.125

634

0,5 kg



IT Cuscino seduta in tessuto per poltroncina art. 7600, 7602,7601, 7603
 EN Seat cushion in fabric for dining armchair art. 7600, 7602,7601, 7603
 DE Stoffkissen für Sitz für Armlehnstuhl Art. 634, 7600, 7602,7601, 7603
 FR Coussin en tissu pour l'assise pour petit fauteuil art. 7600, 7602,7601, 7603
 ES Cojín asiento en tela para butaca art. 7600, 7602,7601, 7603

Fabric

• RANGE 1	€ 75
• RANGE 2	€ 85
• RANGE 3	€ 120
• RANGE LAMINATED	€ 85
• RANGE FIREPROOF	€ 125

7605

16 kg 1 ASS. cm 73 x 69 x 96 m³ 0,483



IT Poltrona lounge in alluminio verniciato con cuscino seduta
 EN Lounge armchair in painted aluminium with cushion for the seat
 DE Lounge-sessel aus lackiertem Aluminium mit Sitzkissen
 FR Fauteuil lounge en aluminium verni avec coussin pour l'assise
 ES Sillón lounge en aluminio lacado con cojín de abajo

Painted alu

ALL COLOURS

Rope

ALL ROPES

Fabric

• RANGE 1	€ 1.705
• RANGE 2	€ 1.840
• RANGE 3	€ 1.960
• RANGE LAMINATED	€ 1.840
• RANGE FIREPROOF	€ 1.990
• CUSTOM FABRICS (0,95ml h,1,40mt)	€ 1.620





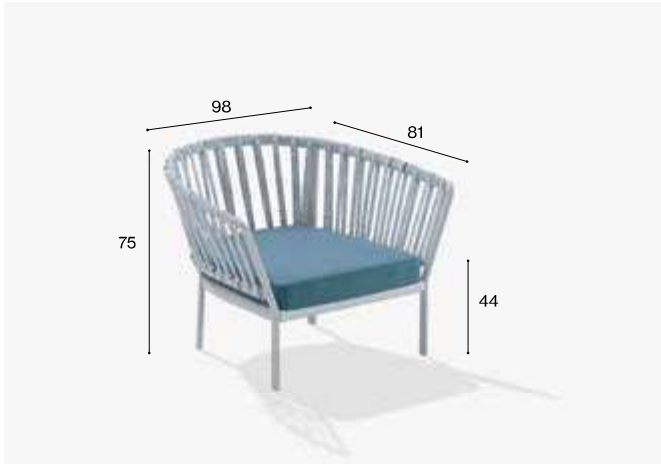

RIA

7611

 20 kg  1 ASS.  cm 99 x 85 x 78 m³ 0,655



IT Poltrona in alluminio verniciato con cuscino seduta
 EN Armchair in painted aluminium with cushion for the seat
 DE Sessel aus lackiertem Aluminium mit Sitzkissen
 FR Fauteuil en aluminium verni avec coussin pour l'assise
 ES Sillón en aluminio lacado con cojín de abajo







Painted alu	Rope	Fabric	Price
ALL COLOURS	ALL ROPES	 • RANGE 1	€ 2.525
		 • RANGE 2	€ 2.725
		 • RANGE 3	€ 2.905
		 • RANGE LAMINATED	€ 2.725
		  • RANGE FIREPROOF	€ 2.805
		• CUSTOM FABRICS (1,50ml h,1,40mt)	€ 2.400

7612

 45 kg  1 ASS.  cm 222 x 94 x 78 m³ 1,608



IT Divano 2 posti in alluminio verniciato con cuscino seduta
 EN 2-seater sofa in painted aluminium with cushion for the seat
 DE Sofa, 2 Plätze, aus lackiertem Aluminium mit Sitzkissen
 FR Canapé 2 places en aluminium verni avec coussin pour l'assise
 ES Sofá 2 plazas en aluminio lacado con cojín de abajo







Painted alu	Rope	Fabric	Price
ALL COLOURS	ALL ROPES	 • RANGE 1	€ 3.670
		 • RANGE 2	€ 3.965
		 • RANGE 3	€ 4.220
		 • RANGE LAMINATED	€ 3.965
		  • RANGE FIREPROOF	€ 4.075
		• CUSTOM FABRICS (3,10ml h,1,40mt)	€ 3.485

7613

 55 kg  1 ASS.  cm 275 x 103 x 78 m³ 2,209



IT Divano 3 posti in alluminio verniciato con cuscino seduta
 EN 3-seater sofa in painted aluminium with cushion for the seat
 DE Sofa, 3 Plätze, aus lackiertem Aluminium mit Sitzkissen
 FR Canapé 3 places en aluminium verni avec coussin pour l'assise
 ES Sofá 3 plazas en aluminio lacado con cojín de abajo

Painted alu	Rope	Fabric	Price
ALL COLOURS	ALL ROPES	 • RANGE 1	€ 4.995
		 • RANGE 2	€ 5.390
		 • RANGE 3	€ 5.740
		 • RANGE LAMINATED	€ 5.390
		  • RANGE FIREPROOF	€ 5.545
		• CUSTOM FABRICS (4,30ml h,1,40mt)	€ 4.745

7614

68 kg 1 ASS. cm 200 x 176 x 80 m³ 2,816



IT Daybed in alluminio verniciato con cuscino seduta
 EN Daybed in painted aluminium with cushion for the seat
 DE Daybed aus lackiertem Aluminium mit Sitzkissen
 FR Daybed en aluminium verni avec coussin pour l'assise
 ES Daybed en aluminio lacado con cojín de abajo

Painted alu	Rope	Fabric	Price
ALL COLOURS	ALL ROPES	• RANGE 1	€ 5.025
		• RANGE 2	€ 5.425
		• RANGE 3	€ 5.780
		• RANGE LAMINATED	€ 5.425
		• RANGE FIREPROOF	€ 5.580
		• CUSTOM FABRICS	€ 4.775
		(5,30ml h.1,40mt)	

636

1,2 kg

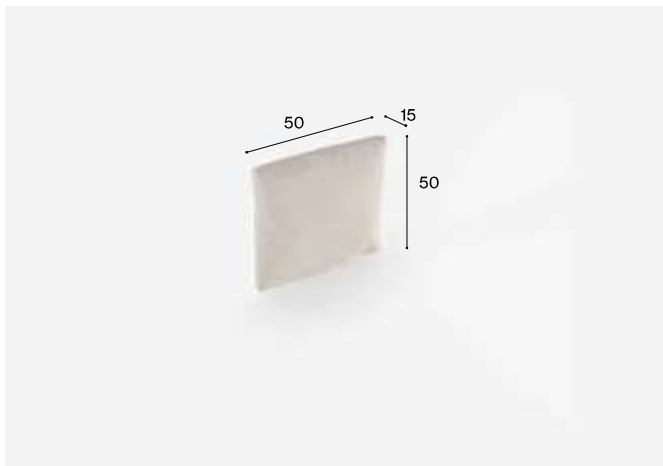

IT Cuscino schienale in tessuto per poltrona, divano e daybed. Sfoderabile
 EN Backrest cushion in fabric for armchair, sofa and daybed. Removable
 DE Rückenkissen aus Stoff für Sessel, Sofa und Daybed. Abziehbar
 FR Coussin dossier en tissu pour fauteuil, canapé et daybed. Déhoussable
 ES Cojín respaldo en tela para sillón, sofá y daybed. Desenfundable

N°1 x art. 7611 - N°2 x art. 7612/7614 - N°3 x art. 7613

Fabric	Price
• RANGE 1	€ 165
• RANGE 2	€ 175
• RANGE 3	€ 190
• RANGE LAMINATED	€ 175
• RANGE FIREPROOF	€ 200
• CUSTOM FABRICS	€ 155
(0,65ml h.1,40mt)	

637

1 kg

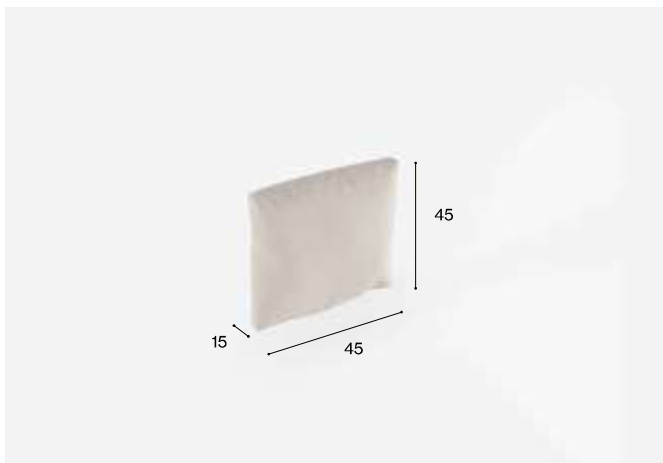

IT Cuscino bracciolo in tessuto per poltrona, divano e daybed. Sfoderabile
 EN Armrest cushion in fabric for armchair, sofa and daybed. Removable
 DE Gepolsterte Armlehne aus Stoff für Sessel, Sofa und Daybed. Abziehbar
 FR Coussin accoudoir en tissu pour fauteuil, canapé et daybed. Déhoussable
 ES Cojín brazo en tela para sillón, sofá y daybed. Desenfundable

Fabric	Price
• RANGE 1	€ 150
• RANGE 2	€ 160
• RANGE 3	€ 170
• RANGE LAMINATED	€ 160
• RANGE FIREPROOF	€ 180
• CUSTOM FABRICS	€ 145
(0,60ml h.1,40mt)	

RIA

613

 0,74 kg

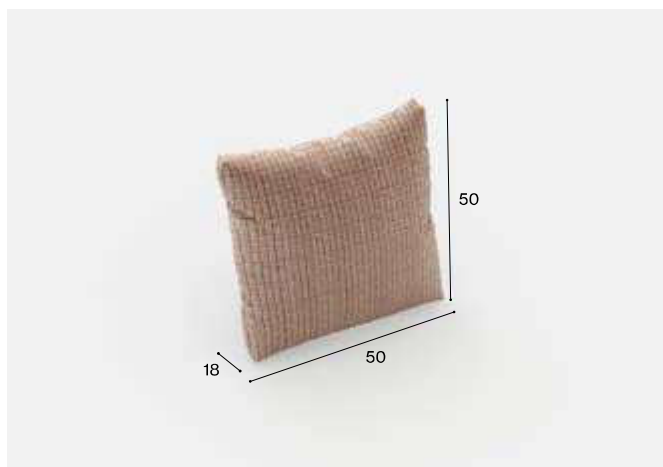

IT Cuscino schienale in tessuto per poltrona lounge. Sfoderabile
EN Backrest cushion in fabric for lounge armchair. Removable
DE Rückenkissen aus Stoff für lounge-sessel. Abziehbar
FR Coussin dossier en tissu pour fauteuil lounge. Déhoussable
ES Cojín respaldo en tela para sillón lounge. Desenfundable

	Fabric	Price
	• RANGE 1	€ 155
	• RANGE 2	€ 165
	• RANGE 3	€ 180
	• RANGE LAMINATED	€ 165
 	• RANGE FIREPROOF	€ 190
	• CUSTOM FABRICS	€ 145
	(0,70 ml h,1,40 mt)	

FRAMES & FABRICS

FINITURE ALLUMINIO • ALUMINIUM FRAMES

Alluminio Verniciato • Painted Aluminium



1
Bianco
White

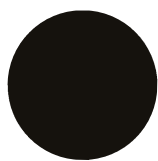

2
Nero
Black



9
Grigio Metallo
Metallic Grey

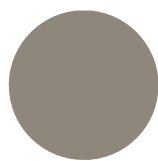

11
Oro Perlato
Pearly Gold

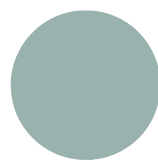

13
Azzurro Pastello
Light Blue

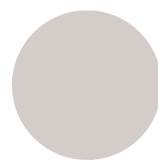

14
Grigio Polvere
Powder Grey



19
Tè Verde
Green Tea



26
Bianco Antico
Antique White



27
Bianco Burro
Butter White

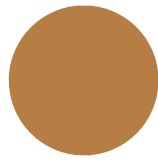

28
Giallo Senape
Mustard Yellow

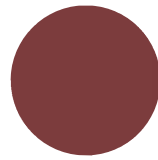

29
Rosso Autunno
Autumn Red

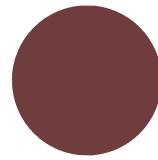

30
Marrone Castagna
Chestnut Brown



31
Verde Bottiglia
Bottle Green



32
Blu Grigio
Grey Blue

Alluminio Puntinato • Speckled Aluminium



1S
Antracite
Anthracite

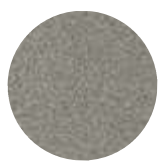

2S
Grigio
Grey

NaturAll



W03
NaturAll Chiaro
Light NaturAll

GRES • STONEWARE

Range 1



GNV
Neve
Snow



GNO
Nocciola
Hazel



GNT
Notte
Night

Range 2



GPL
Polare
Polar



GDO
Dove
Dove



GMN
Mezzanotte
Midnight



GCR
Corten
Corten

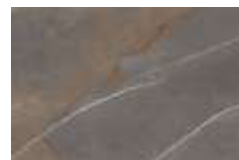

GFU
Grigio Fumé
Smoky Grey

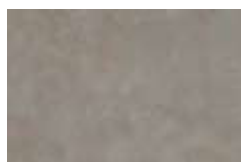

GGC
Grigio Chiaro
Light Grey



GDG
Grigio Scuro
Dark Grey

PIETRA LAVICA • LAVA STONE



PL01
Borgogna
Burgundy



PL02
Abisso
Abyssal

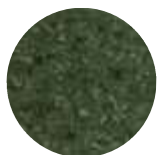

PL03
Foresta
Forest

LEGNO • WOOD



L01
Iroko
Iroko



L02
Rovere Sbiancato
Bleached Oak



L03
Teak
Teak

MALTA • MORTAR



M01
Bianco Burro
Butter White



M02
Oro Perlato
Pearly Gold



M03
Giallo Senape
Mustard Yellow



M04
Grigio Metallo
Metallic Grey

HPL



AN
Antracite
Anthracite

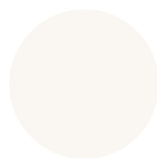

BI
Bianco
White

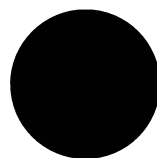

NE
Nero
Black



TA
Tortora
Taupe

TESSUTI • FABRICS

Range 1

Solids 

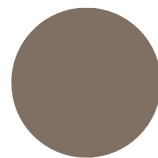

STA
Tortora
Taupe



SLN
Lino
Linen



SCH
Champagne
Champagne



SPE
Perla
Pearl



SMG
Grigio Minerale
Mineral Grey



SGR
Grigio
Grey



SCI
Cannella
Cinnamon

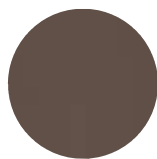

SCC
Cioccolato
Choco

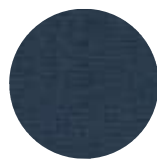

SNA
Navy
Navy

Liso **(agon)**

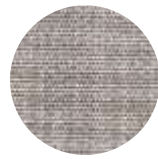

LCE
Cenere
Ash

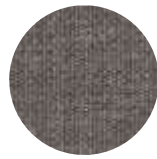

LGF
Grafite
Graphite

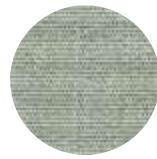

LSA
Salvia
Sage

TESSUTI • FABRICS

Range 2

Heritage recycle  sunbrella



HDS
Deserto
Desert



HCE
Cereale
Cereal

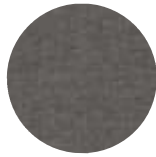

HRO
Strada
Road



HCO
Rame
Coppery



HPI
Pistacchio
Pistachio



HOL
Oliva
Olive



HAL
Pino
Alpine



HGR
Grano
Grain

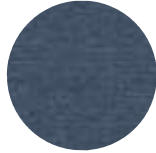

HJE
Jeans
Jeans



HCF
Caffè
Coffee

Positano **RaDa**



POME
Meringa
Meringue



POQU
Quinoa
Quinoa

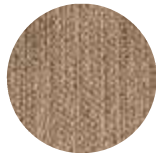

POTB
Tabacco
Tobacco

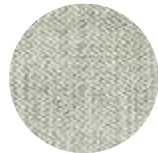

POAL
Aloe
Aloe

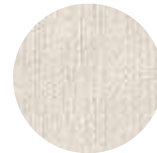

POCL
Nuvola
Cloud



POSL
Ardesia
Slate

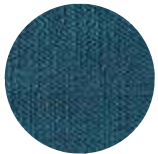

POOC
Ottanio
Octanio



POBB
Mirtillo
Blueberry

Range 3

Lopi 



LOCH
Carbone
Charcoal



LOMR
Marmo
Marble



LOSB
Sabbia
Sand



LOCP
Cappuccino
Cappuccino

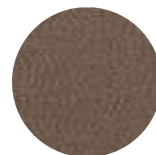

LOGV
Ghiaia
Gravel

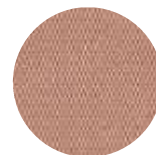

LOSU
Alba
Sunrise

Slow 



SLCN
Cotone
Cotton

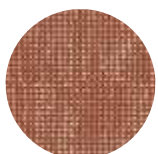

SLPA
Paprika
Paprika



SLMF
Latte-menta
Mint Frost

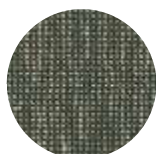

SLSW
Alghe
Seaweed

Gaià **(agona)**



GASF
Fiocco Di Neve
Snowflake



GAVA
Vaniglia
Vanilla

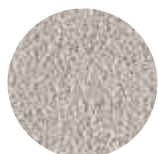

GASG
Grigio Conchiglia
Seashell Grey



GAME
Meteorite
Meteorite

Mojito **marzottointeriors**



MODU
Duna
Dune



MOBR
Bronzo
Bronze



MOIV
Avorio
Ivory



MOCA
Caramello
Caramel

Cosmopolitan **marzottointeriors**



COWL
Bosco
Woodland



COWA
Onde
Waves

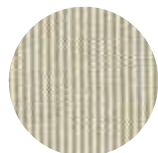

COMU
Fungo
Mushroom

Range 3

Navarone **mariosirtori**



NVSU
Zucchero
Sugar



NVSI
Seta
Silk



NVFL
Fiamma
Flame



NVTA
Grigio Tortora
Taupe Grey



NVMO
Moka
Moka



NVMA
Blu Marino
Marine



NVGL
Ghiacciaio
Glacier

Delta **mariosirtori**



DECY
Cipresso
Cypress



DESP
Zaffiro
Sapphire



DEAM
Acquamarina
Acquamarine

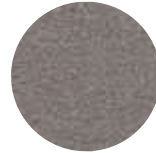

DEDU
Polvere
Dust

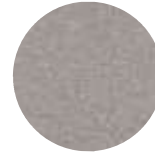

DEWA
Wafer
Wafer



DEPE
Pecan
Pecan



DECN
Zucchero Filato
Cotton Candy



DESA
Salmone
Salmon

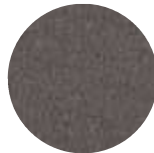

DEMA
Magnete
Magnet

Revira Iris **RaDa**



IRYO
Yogurt
Yogurt

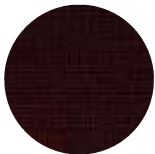

IRCH
Ciliegia
Cherry



IRST
Corda
String



IROA
Avena
Oat



IRNE
Nettuno
Neptune

Range Laminated

Liso Laminated 

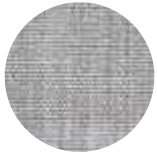

LCEL
Cenere
Ash

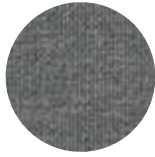

LGFL
Grafite
Graphite

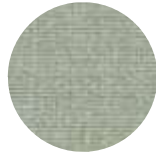

LSAL
Salvia
Sage

Solids Laminated 

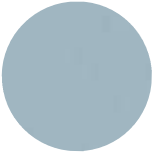

SMIL
Minerale
Mineral



STAL
Tortora
Taupe

Range Fireproof

Atrium **kvadrat**

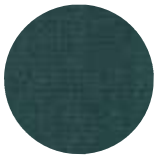

ATAM
Amazzonia
Amazonia



ATAP
Albicocca
Apricot



ATCY
Canyon
Canyon



ATDS
Mare Profondo
Deep Sea



ATLI
Lime
Lime



ATPR
Pergamena
Parchment



ATSV
Savana
Savannah



ATST
Tempesta
Storm



ATVO
Vulcano
Volcano

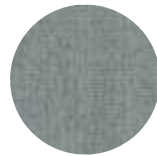

ATWM
Muschio Bianco
White Musk

BATYLINE

Range 1



BBI
Bianco
White

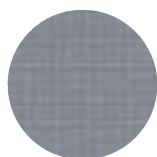

BBR
Blu Ardesia
Slate Blue

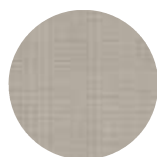

BEC
Ecrú
Ecrú



BGR
Grigio
Grey

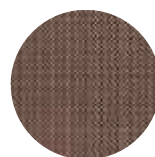

BMA
Marrone
Brown



BNE
Nero
Black

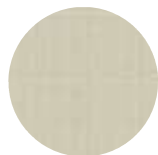

BVE
Verde
Green

Range 2



BCA
Cacao
Cacao



BBE
Beige
Beige



BMK
Latte
Milk

SIMILPELLE • LEATHERETTE



SP01
Ambra
Amber



SP02
Papiro
Papyrus



SP03
Cashmere
Cashmere



SP04
Nero Puro
Pure Black

FELTRO • FELT



FCL
Colonia
Colonia



FDG
Grigio scuro
Dark grey



FPN
Panna
Cream



FRA
Rame
Copper



FTA
Tortora
Taupe

CORDE • ROPES



C01
Arizona
Arizona

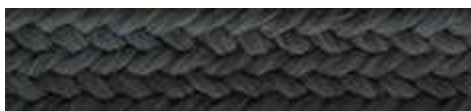

C02
Sabbia Nera
Black Sand



C03
Menta
Mint



C04
Luna
Moon



C05
Roccia
Rock



C06
Tramonto
Sunset



C07
Oceano
Ocean



C08
Brownie
Brownie

CORDE PIATTE • FLAT ROPES



F01
Arizona
Arizona



F02
Sabbia Nera
Black Sand



F03
Menta
Mint



F04
Luna
Moon



F05
Roccia
Rock



F07
Oceano
Ocean



F08
Brownie
Brownie